

Three-Phase Four-Wire Distribution System using Fuzzy Controller based Constant Voltage Control of DC Capacitor for Active Load Balancer

Adapa Raja Sekhar¹, V. V. N. Murthy²

¹PG Scholar, ²Professor, Department of Electrical & Electronics Engineering
 Jawaharlal Nehru Technological University, Kakinada, Andhra Pradesh, India.
¹adaparaj201@gmail.com, ²vnmurthy1@gmail.com

Abstract: Unbalance in the loads often arise in three-phase four-wire distribution systems causing unbalanced voltages and currents and further results in high neutral currents and engender loss in the distribution transformers and therefore low system efficiency. So, to obtain the power factor on the source side near to unity an Active Load Balancer (ALB) based on reactive power control of the constant voltage control of the DC capacitor was proposed. Proportional and Integral controllers (PI) were generally used in the control operations of the ALB. However, due to presence of various disturbances and loads with a non-linear characteristic in the distribution power system so, the PI controllers cannot give best functionality for various working conditions. Consequently, potent controller for instance fuzzy controllers are needed in the distribution power system for power quality enhancement and ameliorate stability of distribution systems. The use of fuzzy controller and working of the ALB are confirmed using simulation in MATLAB/SIMULINK.

Key Words: Reactive Power Control, Constant Voltage Control of DC Capacitor, Instantaneous Active Reactive Power Theory, Active Load Balancer, Fuzzy Controller, Three-Phase Four-Wire Distribution Systems.

I. INTRODUCTION

Generally the loads connected to a three phase four wire distribution systems are unbalanced inductive and power electronic loads. Inductive loads consumes high reactive power and whereas power electronic loads induce harmonics so, these will cause unbalanced load conditions and harmonic pollution in Three-phase four-wire distribution power systems [1-3]. The usual loads hooked up to the Three-phase four-wire distribution system can be unbalanced three-phase non-linear loads or single phase non-linear loads and other power electronic devices [4] which generally have a unbalanced characteristic and cause problems such as high source current harmonics and high neutral currents and cause less distribution system efficiency [5]. The existence of current harmonics in distribution systems raises power losses in the lines, reduces the power factor and causes errors in electronic equipments connected to power system [6]. Due to presence of non-linear loads and unbalanced conditions both the harmonic Positive-sequence and negative-sequence currents are generated [7]. On the other hand, single phase non-linear loads which are bridged between line to neutral generally produce harmonic zero sequence

components [8]. These third order harmonic currents amass arithmetically at the neutral line [9-11].

By using passive filter and active filter we can enhance power quality. Passive filters are broadly acclimated to remove harmonics in distribution system for its modesty and less cost [12-14]. As, passive filters has a lot of problems just as loading problem, huge size and cost, floating input and output and resonance problems. Conventional passive filters cannot effectively remove the complications like current harmonics and excessive neutral current in distribution systems so, four-leg active filters will remove them effectively than conventional passive filters.

To solve the power quality problems in 3 phase 4 wire distribution systems active power conditioners are generally used. These generally consist of voltage source inverter, gate drive circuit and a controller. To calculate the compensation currents two types of controllers are used such as instantaneous active reactive power controllers and DC link controllers.

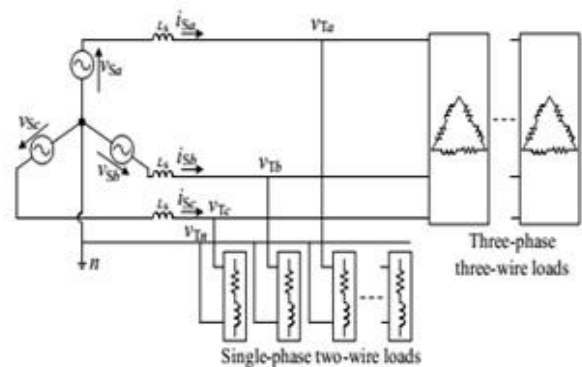

Fig. 1 Three-Phase Four-Wire Distribution Systems

In this paper DC link controller is preferred as the calculation blocks of load current components of unbalanced active currents and reactive currents are not required and are simple.

II. THE OPERATING PRINCIPLE OF THE ACTIVE LOAD BALANCER IN THREE-PHASE FOUR-WIRE DISTRIBUTION SYSTEMS

value, Compensation inductance value and switching frequency of the Active Load Balancer.

Table I. Parameters of Supply

Item	Symbol	Value
Rated line-to-line voltage	V_o	380V
Rated line-to-neutral rms voltage	V_{Sa}, V_{Sb}, V_{Sc}	220V
Rated frequency	f	50 Hz
Source inductance	L_{Sa}, L_{Sb}, L_{Sc}	2.7mH
Source resistance	R_{Sa}, R_{Sb}, R_{Sc}	0.1 Ω

Table II. Loads in Each Phases of Three Phase Four Wire Distribution System

Item	Symbol	Value
a-Phase load Large load condition	R_a	37.5 Ω
	L_a	7.5mH
a-Phase load Small load condition	R_a	150 Ω
	L_a	30mH
b-Phase load	R_b	75 Ω
	L_b	15mH
c-Phase load	R_c	300 Ω
	L_c	60mH

Table III. Constants of the Circuits in Active Load Balancer in Simulation

Item	Symbol	Value
Reference dc-capacitor voltage	V_{DC}^*	820V
Capacitance of capacitor	C_{DC}	2200 μ F
Compensation inductance	L_{Ca}, L_{Cb}, L_{Cc}	3mH
Switching frequency	f_{sw}	12kHz

III. CONCEPTION OF A FUZZY CONTROLLER FOR THE ACTIVE LOAD BALANCER

The fuzzy logic controller is established on the artificial intelligence and provides superior performance than the conventional controllers. Fuzzy controllers can efficaciously used to regulate the performance of the system. Fig. 6 shows a fuzzy control system. The fuzzy controller has several components:

- A set of rules base that decide how to execute control.
- Fuzzification that transforms the input variables and scales to fuzzy sets so that the inference mechanisms can understand.

- Inference mechanism which uses the approximate reasoning and deduce the required control action.
- Defuzzification is used to convert the fuzzy values to the required control signals.

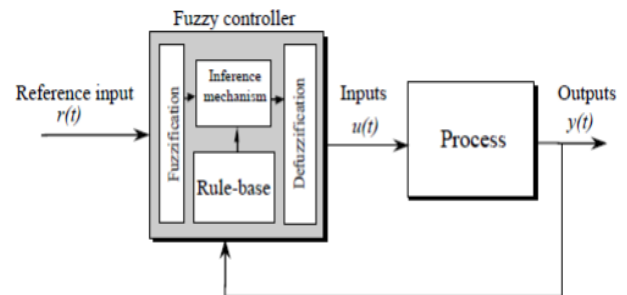

Fig. 6 Fuzzy Control System

In the table IV the basic criterion for the fuzzy controller was displayed. The fuzzy controller is having two inputs and for every input there are seven semantic values. Finally there are 49 available combinations for the criterions.

The semantic values are given by

ZO=Zero

PS=Positive Small

PB=Positive Big

PM=Positive Medium

NS=Negative Small

NB=Negative Big

NM=Negative Medium

Table IV. If-Then Rules for Fuzzy Inference System

u(t)	e(t)							
		NB	NM	NS	ZO	PS	PM	PB
$\Delta e(t)$	NB	NB	NB	NB	NB	NM	NS	ZO
	NM	NB	NB	NB	NM	NS	ZO	PS
	NS	NB	NB	NM	NS	ZO	PS	PS
	ZO	NB	NM	NS	ZO	ZO	PM	PM
	PS	NM	NS	ZO	PS	PS	PB	PB
	PM	NS	ZO	PS	PM	PM	PB	PB
	PB	ZO	PS	PM	PB	PB	PB	PB

Fuzzy logic has following advantages correlated to customary PI controllers they are

- Specific mathematical prototype not necessary.
- Function with surmised inputs.
- These may helve non linearities.

So, PI controllers is replaced with Fuzzy logic controller to provide sufficient voltage control and improve the stability of three phase four wire distribution system and the results are simulated using MATLAB software.

The inputs to the fuzzy controller are error of input $e(t)$ and the rate of change of error of input $\dot{e}(t)$ and the output of the controller is ΔI_d .

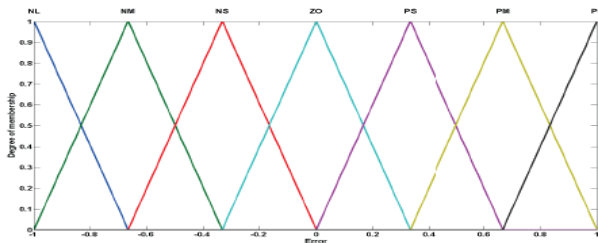

Fig.7 Degree of Membership of the Error of Input $e(t)$

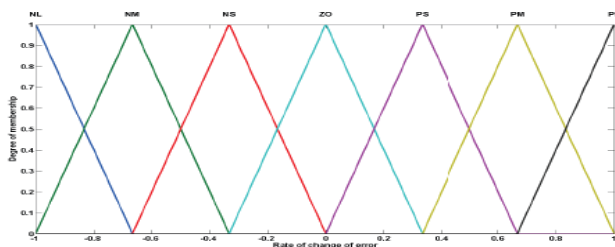

Fig. 8 Degree of Membership of the Rate of Change of Error of Input $\dot{e}(t)$

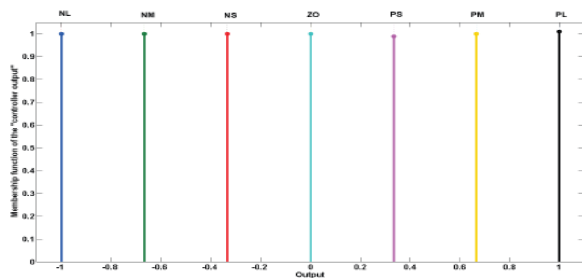

Fig. 9 Degree of Membership of the Output of Fuzzy Controller

Fig.7 and Fig.8 shows the triangular membership functions of the error of input $e(t)$ and the rate of change of error of input $\dot{e}(t)$ respectively and Fig.9 shows the degree of membership of the output of fuzzy controller. By taking the triangular membership functions of the inputs and Mamdani fuzzy inference mechanism into consideration Fuzzy controller design.

IV. MATLAB/SIMULATION RESULTS

Case A: Proposed Light Load Variation with PI Control:

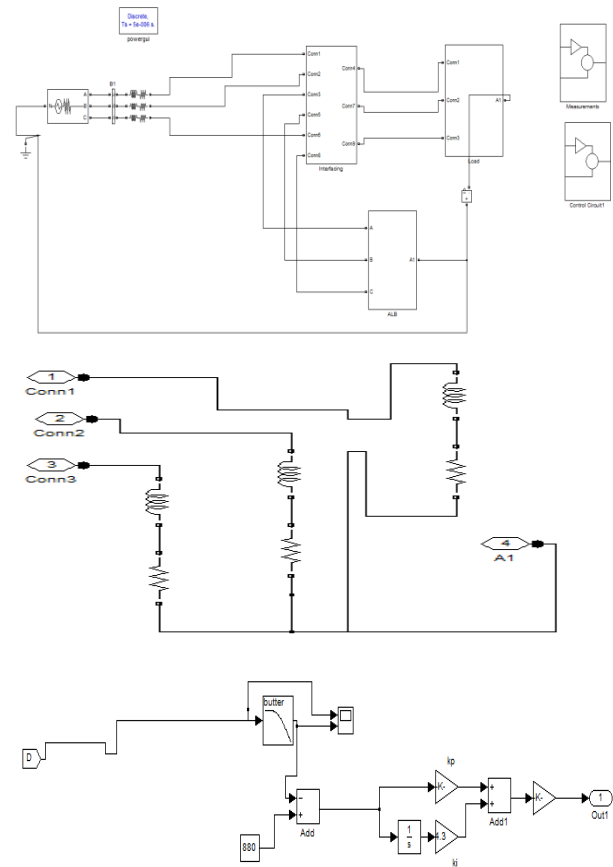

Fig.10 Simulink Model of Constant Voltage Control of DC Capacitor Design for ALB With PI Control Showing Circuit, Load and PI Control Circuit

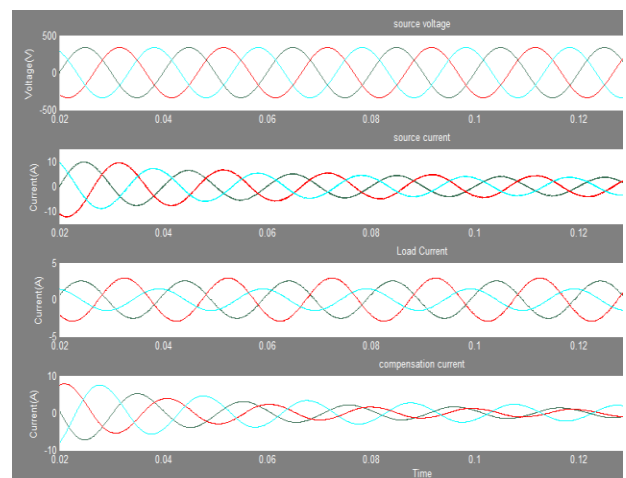

Fig. 11 Waveforms of Source Voltage (V_s), Source Current (I_s), Load Current (I_L) and Compensation Current (I_c)

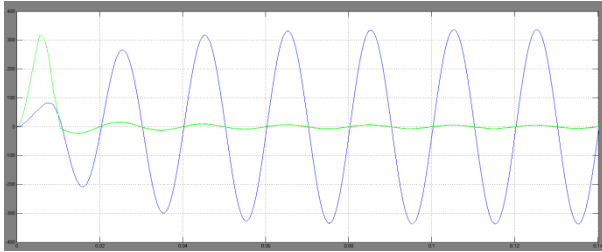

Fig.12 Angle in Degrees Between Source Voltage (V_s) and Source Current (I_s)

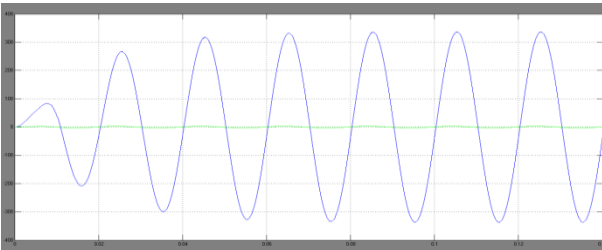

Fig. 13 Angle In Degrees Between Load Voltage (V_T) and Load Current (I_L)

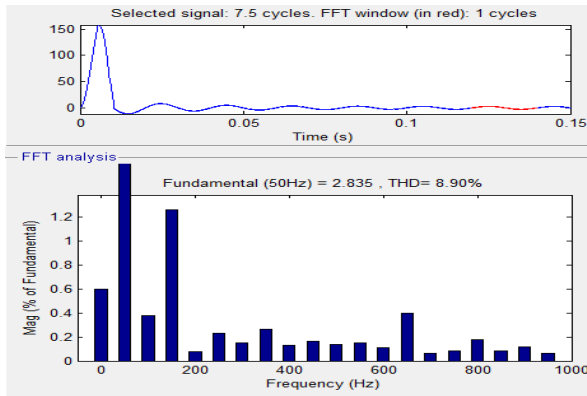

Fig. 14 Harmonic Distortion in Source Current (I_s)

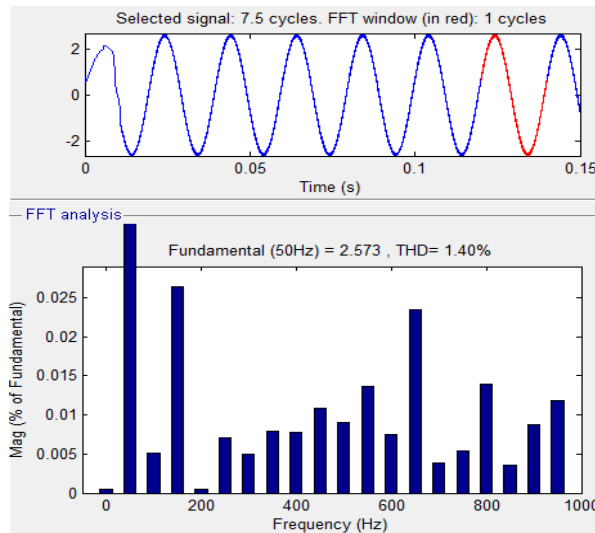

Fig. 15 Harmonic Distortion in Load Current (I_L)

Case B: Proposed Switching of Load from Light Load Condition to Heavy Load Condition with PI Control:

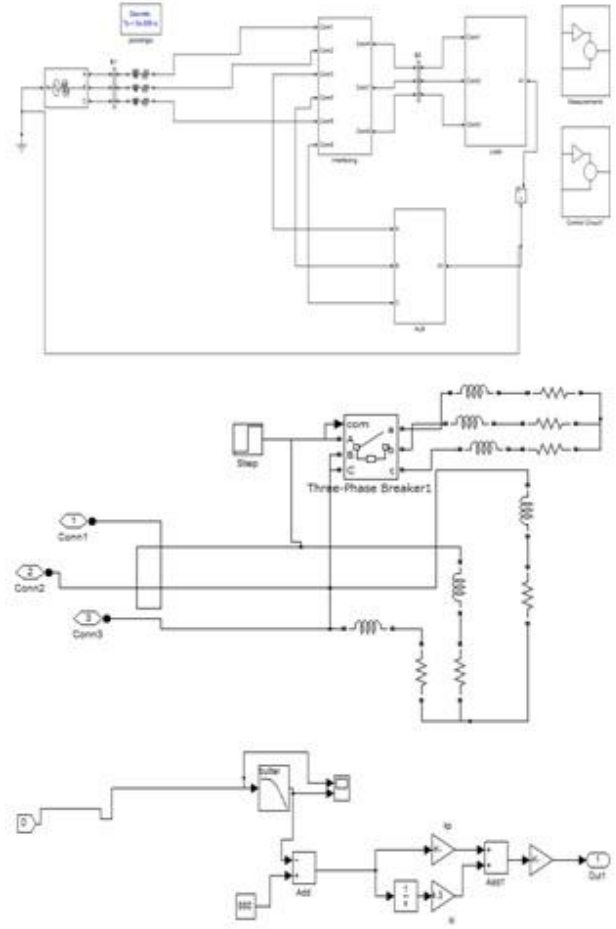

Fig. 16 Simulink Model of Constant Voltage Control of DC Capacitor Design for ALB with PI Control Showing Circuit, Light Load to Heavy Load Switching and PI Control Circuit

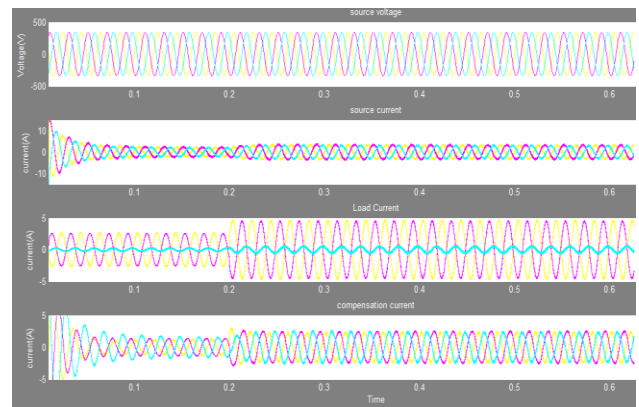

Fig. 17 Waveforms of Source Voltage (V_s), Source Current (I_s), Load Current (I_L) & Compensation Current (I_c)

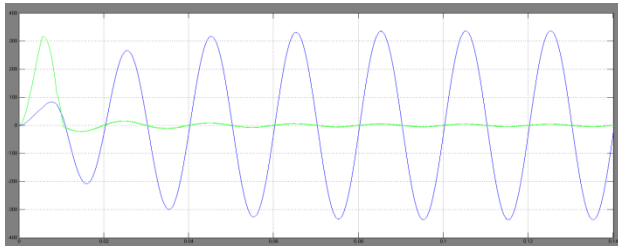

Fig. 18 Angle in Degrees Between Source Voltage (V_S) and Source Current (I_S)

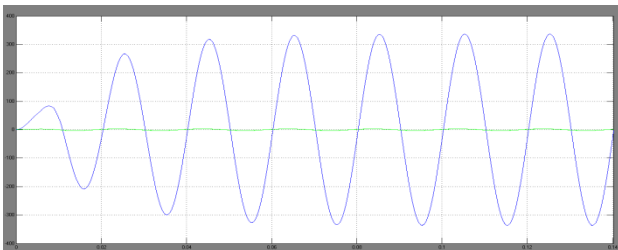

Fig. 19 Angle in Degrees Between Load Voltage (V_T) and Load Current (I_L)

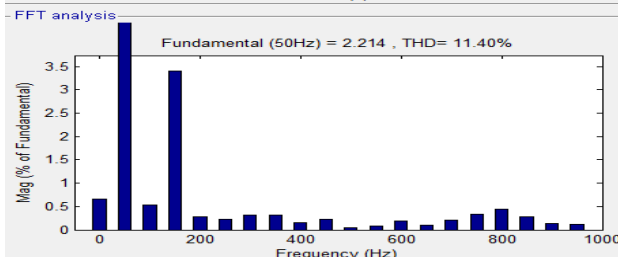
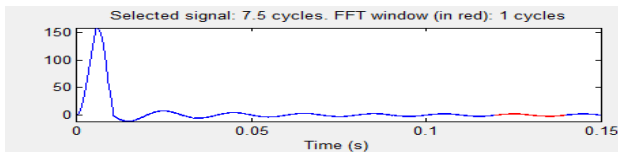

Fig. 20 Harmonic Distortion in Source Current (I_S)

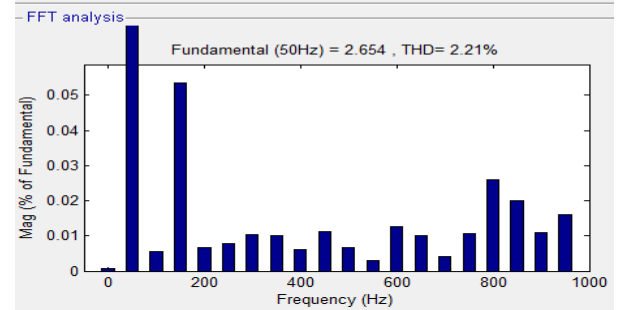
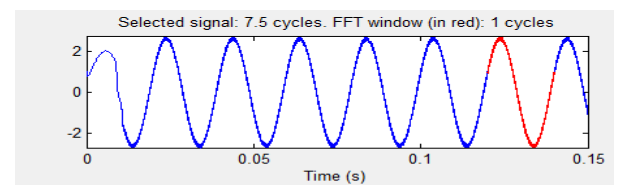
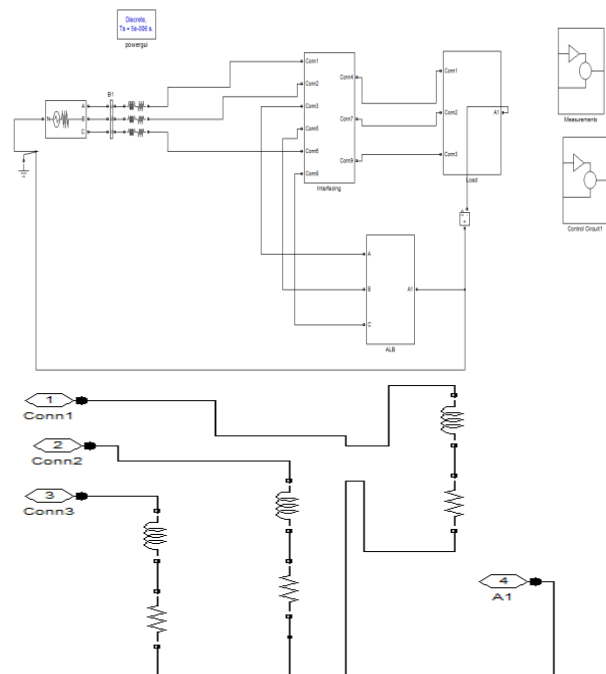

Fig. 21 Harmonic Distortion in Load Current (I_L)

Case A and Case B corresponds to the operation of the Active Load Balancer during the light load variation and load switching from light load to heavy load condition with the use of PI control. Fig. 10 and Fig. 16 shows the MATLAB model of the Active Load Balancer during the changes in the load using PI control. Fig. 11 and Fig. 17 are the waveforms of the Source Voltage(V_S), Source Current(I_S), Load Current(I_L) and Compensation Current(I_C) plots respectively of the Active Load Balancer using PI control. Fig. 12 and Fig. 18 shows the angle in degrees between source voltage (V_S) and source current (I_S) and Fig. 13 and Fig. 19 are the angle in degrees between load voltage (V_T) and load current (I_L) respectively from these waveforms we can observe the improvement of power factor. Fig. 14 and Fig. 15 are the harmonic distortion analysis of the source current (I_S) and load current (I_L) and the values are 8.90% and 1.40% respectively during the light load variation and Fig. 20 and Fig. 21 represent the harmonic distortion analysis the source current (I_S) and load current (I_L) and the values are 11.40% and 2.21% during the load switching from light load to heavy load condition respectively and these Total harmonic distortion (THD) values are more than the IEEE limit of 5%. The compensator turns on at 0.02 seconds during the light load variation and in the case of a change in the load i.e. from light load to heavy load variation the ALB will enhance the power quality and it turns on at 0.01 seconds. So, response of the controller is fast.

Case C: Proposed Light Load Variation with Fuzzy Logic Control:



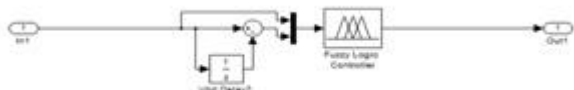

Fig. 22 Simulink Model of Constant Voltage Control of DC Capacitor Design for ALB with Fuzzy Logic Controller Showing Circuit, Load Circuit and Fuzzy Logic Control Circuit

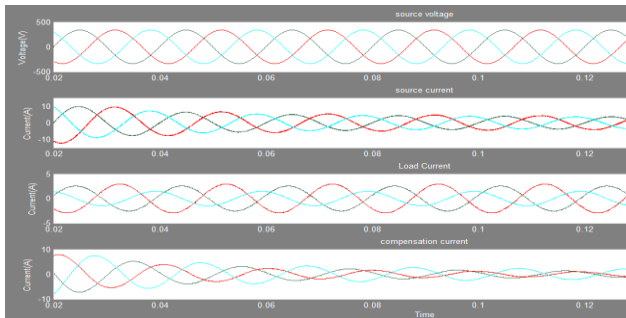

Fig. 23 Waveforms of Source Voltage (V_s), Source Current (I_s), Load Current (I_L) and Compensation Current (I_c)

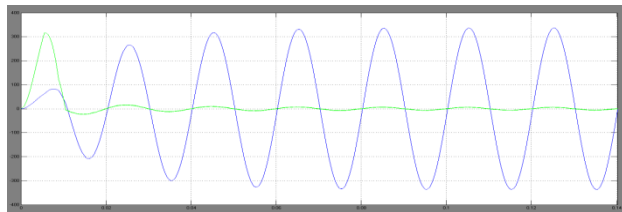

Fig. 24 Angle in degrees between Source Voltage (V_s) and Source Current (I_s)

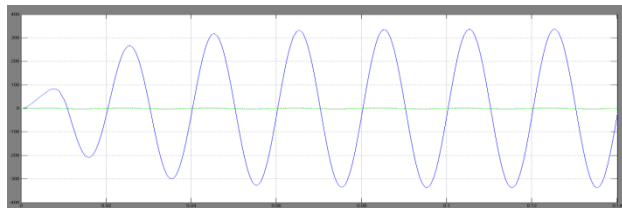

Fig. 25 Angle in Degrees between Load Voltage (V_r) and Load Current (I_L)

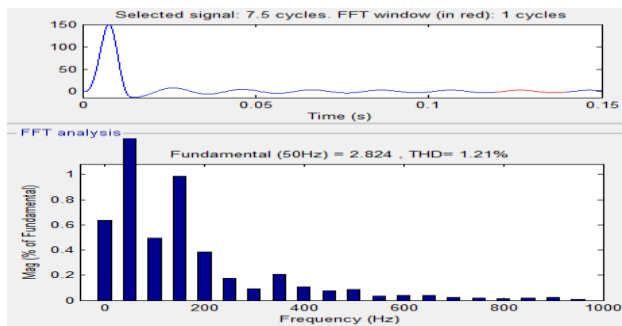

Fig. 26 Harmonic Distortion in Source Current (I_s)

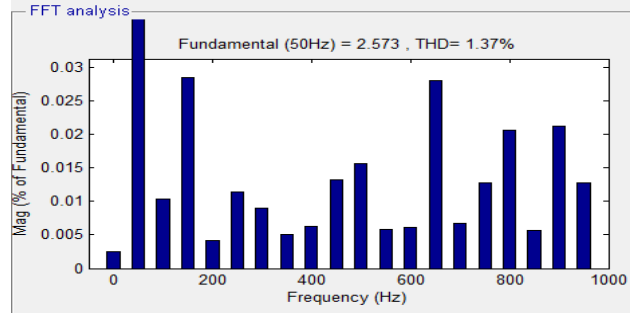
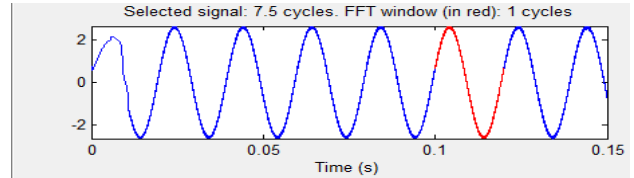

Fig. 27 Harmonic Distortion in Load Current (I_L)

Case D: Proposed switching of load from Light Load condition to Heavy Load condition with Fuzzy Logic Control:

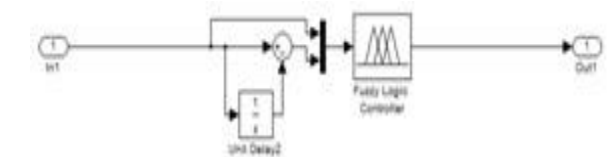
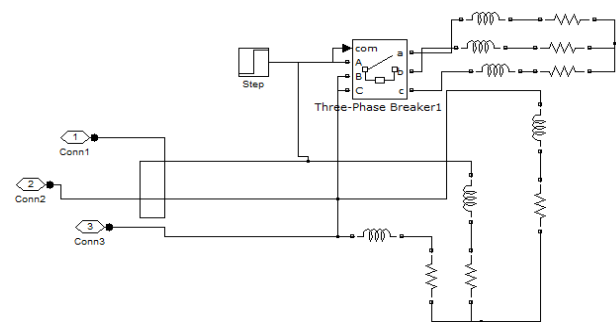
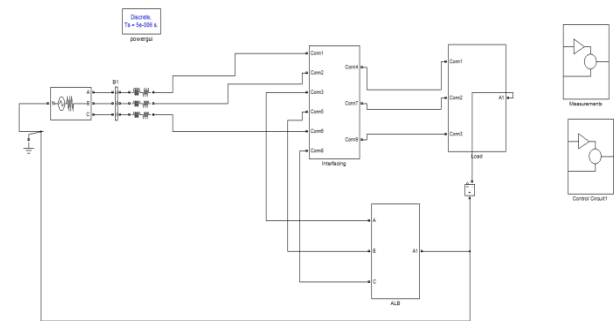

Fig. 28 Simulink Model of Constant Voltage Control of DC Capacitor Design for ALB with Fuzzy Logic Controller Showing Circuit, Light Load to Heavy Load Switching and Fuzzy Logic Control Circuit.

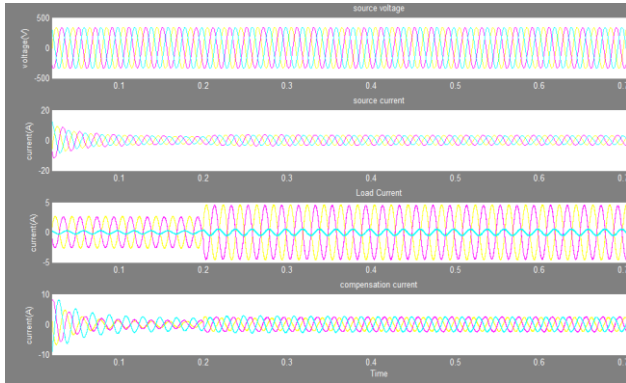

Fig. 29 Waveforms of Source Voltage (V_s), Source Current (I_s), Load Current (I_L) and Compensation Current (I_c)

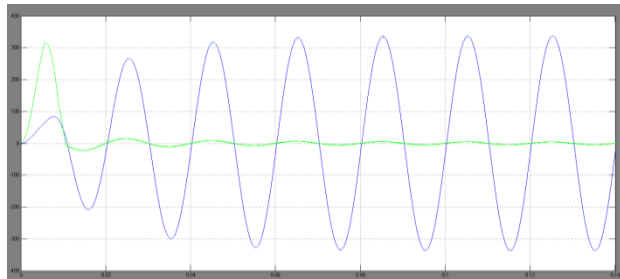

Fig. 30 Angle in Degrees between Source Voltage (V_s) and Source Current (I_s)

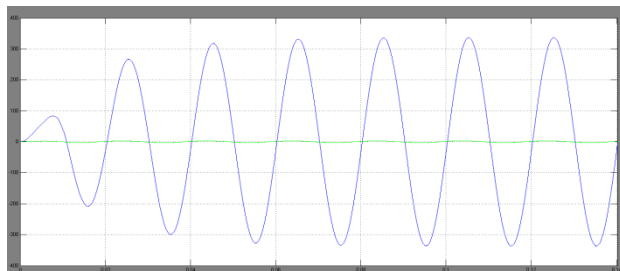

Fig. 31 Angle in Degrees between Load Voltage (V_r) and Load Current (I_L)

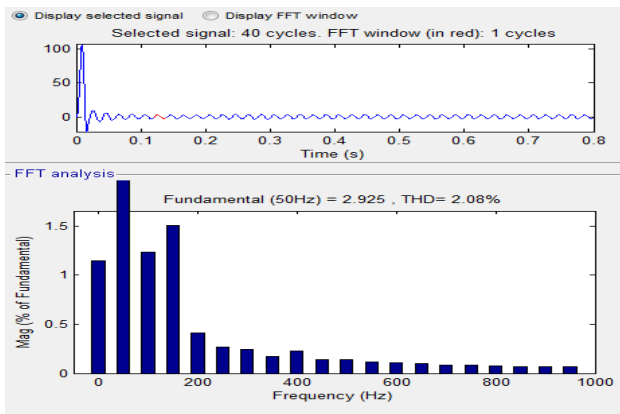

Fig. 32 Harmonic Distortion in Source Current (I_s)

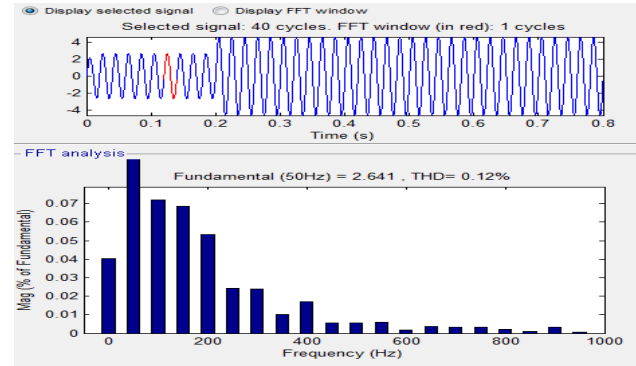

Fig. 33 Harmonic Distortion in Load Current (I_L)

Case C and Case D discuss the working of the Active Load Balancer during the light load variation and load switching from light load to heavy load condition with the use of Fuzzy control. Fig. 22 and Fig. 28 display the MATLAB model of the Active Load Balancer during the transitions in the load using fuzzy control. Fig. 23 and Fig. 29 are the waveforms of the Source Voltage (V_s), Source Current (I_s), Load Current (I_L) and Compensation Current (I_c) plots respectively of the Active Load Balancer using Fuzzy control. Fig. 24 and Fig. 30 shows the angle in degrees between source voltage (V_s) and source current (I_s) and Fig. 25 and Fig. 31 are the angle in degrees between load voltage (V_r) and load current (I_L) respectively from these waveforms we can perceive the enhancement of power factor. Fig. 26 and Fig. 27 represents the harmonic distortion analysis of the source current (I_s) and load current (I_L) and the values are 1.21% and 1.37% respectively during the light load variation and Fig. 32 and Fig. 33 manifest the harmonic distortion analysis the source current (I_s) and load current (I_L) and the values are 2.08% and 0.12% during the load switching from light load to heavy load condition respectively and these Total harmonic distortion (THD) values are within the IEEE limit of 5%. The compensator turns on at 0.02 seconds during the light load variation and in the case of a change in the load i.e. from light load to heavy load variation the ALB will enhance the power quality and it turns on at 0.01 seconds. So, response of the controller is fast.

And for the fuzzy controller design THD analysis of source current (I_s) and load current (I_L) is of very low value compared to that of the PI controller and also those are within the IEEE limit of 5%. So, Fuzzy logic controller is the best control for the operation of the Active Load Balancer.

V. CONCLUSION

Fuzzy controller has been examined and exhibited the use and applicability of the Active Load Balancer for voltage control in three phase four wire distribution systems. Due

to various benefits of Fuzzy controller, the conventional PI controllers are replaced with fuzzy logic controller for better stability. MATLAB simulation inspection was performed to approve the capability of the Active load balancer with constant voltage control of DC capacitor. Gating signals needed for the operation of the Active Load Balancer were provoked using d-q method from the reference compensation currents calculated in the system and PLL and Hysteresis current controller so, the synchronization problems were very less. Simulation studies in MATLAB/SIMULINK display that fuzzy controller based constant voltage control of DC capacitor for Active load balancer can balance the source currents and obtain the sinusoidal waveform with a power factor near to unity.

VI. REFERENCES

- [1] A. Nava-Segura and G. Mino-Aguilar, "Four-branches-inverter-based active-filter for unbalanced 3-phase 4-wires electrical distribution systems," Proc. IEEE Ind. Appl. Conf., Vol. 4, pp. 2503-2508, 2000.
- [2] P. Acuna, L. Morgan, M. Rivera, J. Dixon, and J. Rodriguez. "Improved active power filter performance for renewable power generation systems." IEEE Trans. Power Electron. Vol. 22. pp. 602-612. Mar. 2007.
- [3] F. Z. Peng, G. W. Ott, D. J. Adams, "Harmonic and reactive power compensation based on the generalized instantaneous reactive power theory for the three-phase four-wire systems," IEEE tran. on Power Electron., Vol. 13, pp. 1174-1181, 1998.
- [4] B. N. Singh, P. Rast, "A new topology of active filter to correct power factor, compensate harmonics, reactive power and unbalance of three phase four-wire loads," IEEE Appl. Power Electron. and Expo., Vol. 1, pp. 141-147, 2003.
- [5] N. Gedda, S.B. Karanki, M.K. Mishra, and B.K. Kumar, "Modified four leg DSTATCOM topology for compensation of unbalanced and nonlinear loads in three phase four wire system," Proc. of EPE'11, pp. 1-10, 2011.
- [6] J.W. Dixon, J.J. Garcia, and L. Moran, "Control system for three-phase active power filter which simultaneously compensates power factor and unbalanced loads," IEEE Trans. Ind. Electron., Vol. 42, pp. 636-641, 1995.
- [7] A. Abllan, G. Garcera, M. Pascual and E. Figueres, "A new current controller applied to four-branch inverter shunt active filters with UPF control method," Proc. of PESC'01, Vol. 3, pp. 1402-1407, 2001.
- [8] Tint Soe Win, E. Hiraki, M. Okamoto, S.R. Lee and T. Tanaka, "Constant DC capacitor voltage control based strategy for active load balancer in three-phase four-wire distribution system," Proc. of ICEMS 2013 International Conf., pp. 1560-1565, 2013.
- [9] H. Akagi, Y. Kanazawa, and A. Nabe, "Instantaneous reactive power compensators comprising switching devices without energy storage components," IEEE Trans. Ind. Appl., Vol. IA-20, No. 3, pp. 625-630, May/June 1984.
- [10] L.N. Arruda, S.M. Silva, and B.J.C. Filho, "PLL structure for utility connected systems," Conf. Rec. 36th IEEE-IAS Ann. Meeting, pp. 2655-2660, Chicago, USA, 2001.
- [11] A. Adya, A.P. Mittal, and J.R.P. Gupta, "Modeling and control of DSTATCOM for three-phase, four-wire distribution systems," IEEE-IAS Ann. Meeting, Vol. 4, pp. 2428-2434, 2005.
- [12] F. S. Zhang, "Control of single phase power converter in D-Q rotating coordinates," U.S Patent 6 621 252 B2, Sep. 16, 2003.
- [13] IEEE 519-1992, "Recommended Practices and Requirements for Harmonic Control in Electrical Power Systems," 1992.
- [14] H. Fujita, S. Tominaga and H. Akagi, "Analysis and design of a DC voltage-controlled static Var compensator using quad-series voltage source inverters," IEEE Trans. on Ind. Appl., 1996; 32(4) 970-978.